

PRODUCT SPECIFICATIONS

Elkay Lustertone™ Classic Stainless Steel 25" x 22" x 6-1/2", Single Bowl Drop-in ADA Sink. Sink is manufactured from 18 gauge 304 Stainless Steel with a Lustrous Satin finish, Rear Center drain placement, and Bottom only pads.

Installation Type:	Drop-in
Material:	304 Stainless Steel
Finish:	Lustrous Satin
Gauge:	18
Sound Deadening:	Bottom only pads
Number of Bowls:	1
Sink Dimensions:	25" x 22" x 6-1/2"
Bowl 1 Dimensions:	21" x 15-3/4" x 6-1/8"
Drain Size:	3-1/2" (89mm)
Drain Location:	Rear Center
Minimum Cabinet Size:	30"
Mounting Hardware:	Part # 64090012 included for countertops up to 3/4" (19mm) thick
Template Included:	No
Cutout Template #:	1000001188

Template is available for download at [elkay.com](#). CAD software will be required to open the template.

Cutout Dimensions for Drop-in Installation:
24-3/8" x 21-3/8" (619mm x 543mm) with 1-1/2" (38mm) corner radius

Custom Options	
<input type="checkbox"/> Type 316 Stainless Steel	
Drain Location	
<input type="checkbox"/> Right Rear	<input type="checkbox"/> Left Rear
<input type="checkbox"/> Center	<input type="checkbox"/> Center Rear
Overflow Location	
<input type="checkbox"/> Front	<input type="checkbox"/> Rear
Alternate Punching	
<input type="checkbox"/> Faucet Model:	<input type="checkbox"/> Punch Required:
Sink Size	
<input type="checkbox"/> Bowl Depth:	<input type="checkbox"/> Drainboard Width:



A Century of Tradition and Quality. For more than 100 years, Elkay has been making innovative products and providing exceptional customer care. We take pride in offering plumbing products that make life easier, inspire change and leave the world a better place.



Product Compliance: ADA & ICC A117.1
ASME A112.19.3/CSA B45.4
Buy American Act



Sinks are listed by IAPMO® as meeting the applicable requirements of the Uniform Plumbing Code®, International Plumbing Code®, and National Plumbing Code of Canada.



Complies with ADA & ICC A117.1 accessibility requirements when installed according to the requirements outlined in these standards.

[Clean and Care Manual \(PDF\)](#)
[Installation Instructions \(PDF\) - 100005236](#)
[Warranty \(PDF\)](#)

Similar models are available with: CuVerro antimicrobial copper, Quick-Clip Mounting System, additional ADA depths

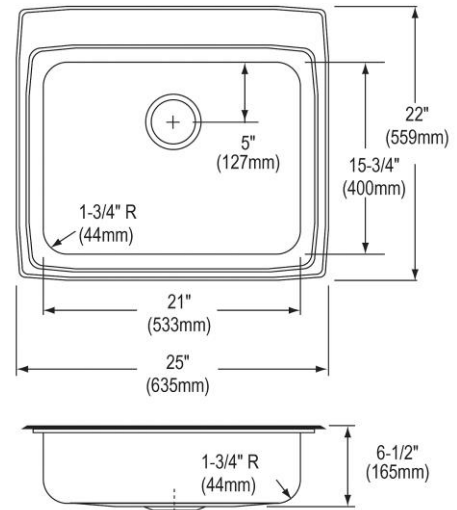

PART: _____ QTY: _____
PROJECT: _____
CONTACT: _____
DATE: _____
NOTES: _____
APPROVAL: _____

In keeping with our policy of continuing product improvement, Elkay reserves the right to change product specifications without notice. Please visit [elkay.com](#) for the most current version of Elkay product specification sheets. This specification describes an Elkay product with design, quality, and functional benefits to the user. When making a comparison of other producers' offerings, be certain these features are not overlooked.



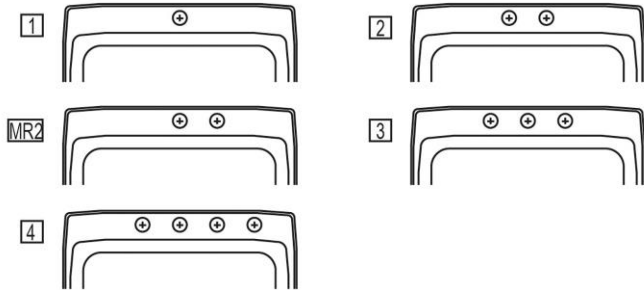

Hole Drilling Configurations:

1-1/2" (38mm) Diameter Faucet Holes on 4" (102mm) Centers

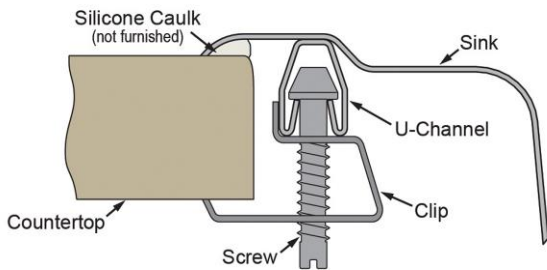



Installation Profile:



Optional Accessories		
LKWOBG2115SS	Elkay Stainless Steel 20" x 14-3/4" x 1" Bottom Grid Spec Sheet (PDF)	
CB1516	Elkay Hardwood 15" x 16-3/4" x 3/4" Cutting Board Spec Sheet (PDF)	
LK99	Elkay Deluxe 3-1/2" Drain Type 304 Stainless Steel Body Strainer Basket Rubber Seal and Tailpiece Spec Sheet (PDF)	
LKGT1041CR	Elkay Gourmet Single Hole Kitchen Faucet Pull-out Spray and Lever Handle with Hi and Mid-rise Base Options Chrome Spec Sheet (PDF)	
LKGT1041NK	Elkay Gourmet Single Hole Kitchen Faucet Pull-out Spray and Lever Handle with Hi and Mid-rise Base Options Brushed Nickel Spec Sheet (PDF)	

In keeping with our policy of continuing product improvement, Elkay reserves the right to change product specifications without notice. Please visit elkay.com for the most current version of Elkay product specification sheets. This specification describes an Elkay product with design, quality, and functional benefits to the user. When making a comparison of other producers' offerings, be certain these features are not overlooked.

LKGT1041RB	Elkay Gourmet Single Hole Kitchen Faucet Pull-out Spray and Lever Handle with Hi and Mid-rise Base Options Oil Rubbed Bronze Spec Sheet (PDF)	
LKWERBSS	Elkay Stainless Steel 15-3/8" x 12-3/8" x 5-7/16" Rinsing Basket Spec Sheet (PDF)	

In keeping with our policy of continuing product improvement, Elkay reserves the right to change product specifications without notice. Please visit elkay.com for the most current version of Elkay product specification sheets. This specification describes an Elkay product with design, quality, and functional benefits to the user. When making a comparison of other producers' offerings, be certain these features are not overlooked.